

5MP WDR Starlight Network IR Fixed Dome Camera

IPC3615ER3-ADUPF28 (40)M



Key Features

Optics

- Starlight illumination
- Day/night functionality
- Up to 120 dB WDR (Wide Dynamic Range)
- Smart IR, up to 30 m (98 ft) IR distance

Compression

- Ultra 265, H.265, H.264, MJPEG
- Embedded smart algorithm
- Triple streams
- 9:16 corridor format

Network

- ONVIF Conformance

Structure

- Wide temperature range: -30°C to 60°C (-22°F to 140°F)
- Wide voltage range of $\pm 25\%$
- 4 KV surge protection designed for network interface

- IP67

Specifications

	IPC3615ER3-ADUPF28M	IPC3615ER3-ADUPF40M
Camera		
Sensor	1/2.7", progressive scan, 5.0 megapixel, CMOS	
Lens	2.8mm@F1.6	4.0mm@F1.6
Angle of view(H)	105.75°	86.9°
Shutter	Auto/Manual, 1/6~1/100000 s	
Minimum Illumination	Colour: 0.005Lux (F1.6, AGC ON) 0 Lux with IR	
Day/Night	IR-cut filter with auto switch (ICR)	
Digital noise reduction	2D/3D DNR	
S/N	>52 dB	
IR Range	Up to 30m (98 ft) IR range	
Defog	Digital Defog	
WDR	120dB	
Video		
Video Compression	Ultra 265,H.265, H.264, MJPEG	
H.264 code profile	Baseline profile, Main Profile, High Profile	
Frame Rate	Main Stream: 5MP(2592 x 1944): Max. 20 fps, 4MP(2560 x 1440): Max. 30 fps, 3MP(2048x 1536): Max. 30 fps, 2MP(1920 x 1080): Max. 30 fps; Sub Stream:2MP(1920 x 1080): Max. 30 fps; Third Stream: D1(720 x 576): Max.30 fps;	
HLC	Supported	
BLC	Supported	
9:16 Corridor Mode	Supported	
OSD	Up to 8 OSDs	
Privacy Mask	Up to 8 areas	
ROI	Up to 8 areas	
Motion Detection	Up to 4 areas	
Smart		
Behavior Detection	Intrusion, cross line, motion detection	
Intelligent Identification	Face detection, Defocus, Scene Change	
Statistical Analysis	People counting	
General Function	Watermark, IP Address Filtering, Tampering Alarm, Access Policy, ARP Protection, RTSP Authentication, User Authentication	
Audio		
Audio Compression	G.711	
Suppression	Supported	
Sampling Rate	8 KHZ	
Network		
Protocols	IPv4, IGMP, ICMP, ARP, TCP, UDP, DHCP, PPPoE, RTP, RTSP, RTCP, DNS, DDNS, NTP, FTP, UPnP, HTTP, HTTPS, SMTP, 802.1x, SNMP	

Compatible Integration	ONVIF(Profile S), API
Interface	
Network	1 RJ45 10M/100M Base-TX Ethernet
Built-in Mic	Supported
General	
Power	12 V DC±25%, PoE (IEEE802.3 af)
	Power consumption: Max 8.9W
Dimensions (∅ x H)	∅126 x 94 mm (∅5.0" x 3.7")
Weight	0.41 kg(0.90 lb)
Operating Conditions	-30°C ~ +60°C (-22°F ~ 140°F), Humidity :10%~95% RH(non-condensing)
Ingress Protection	IP67

Dimensions

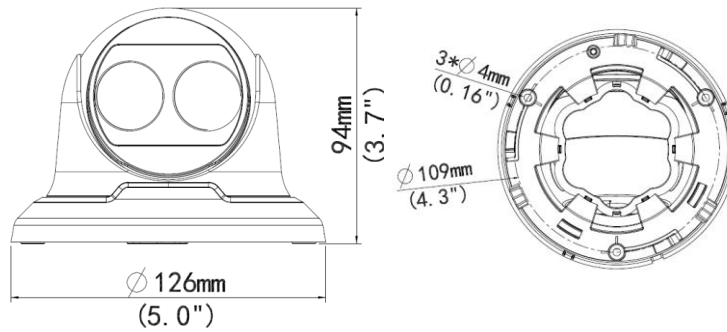

Zhejiang Uniview Technologies Co.,Ltd.

South Tower, Building 10, Wanlun Science Park, 88 Jiangling Road, Hangzhou, P.R.China 310051

Email: overseasbusiness@uniview.com; globalsupport@uniview.com

<http://www.uniview.com>

©2018 Zhejiang Uniview Technologies Co.,Ltd. All rights reserved.

*Product specifications and availability are subject to change without notice.